

MORSA+

Art. 1121.20 - 1123.20

- Cerniera a 2 ali per aperture interne/esterne
- 2 wing hinge for internal/external openings
- Paumelle à 2 lames pour ouvertures intérieures/extérieures
- Bisagra de 2 alas para aberturas internas/externas

1121.20

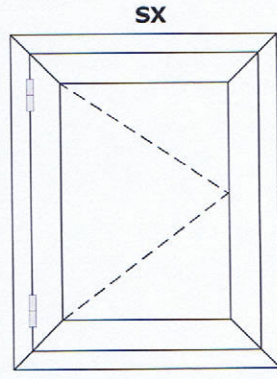
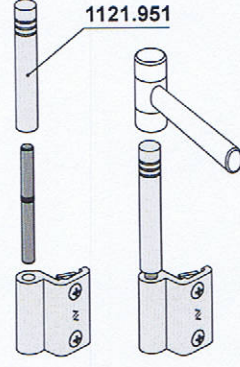
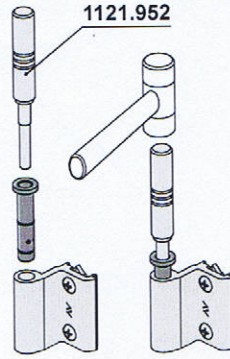
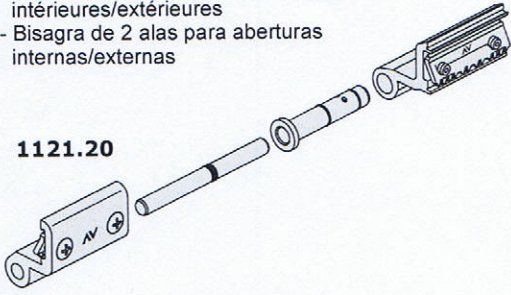

- Cerniera a 2 ali per terza anta
- 2 wing hinge for third casement
- Paumelle à 2 lames pour le troisième vantail
- Bisagra de 3 alas para la tercera hoja

1123.20

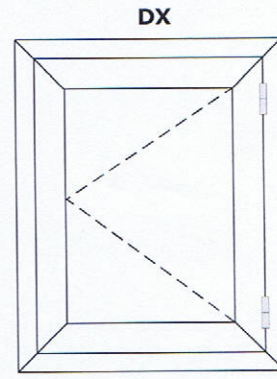
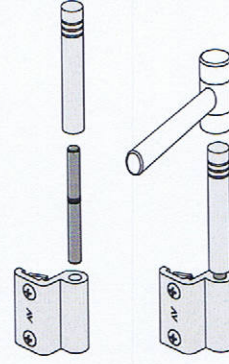
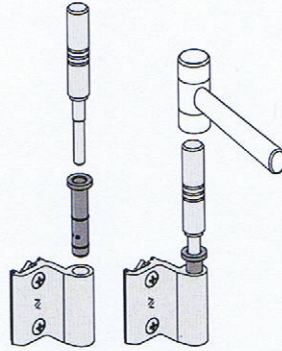
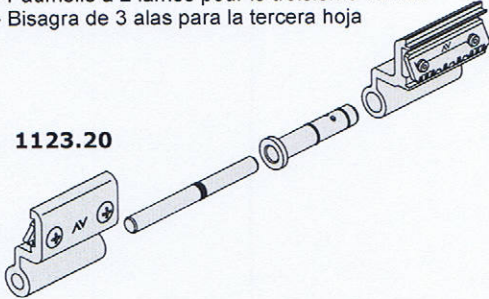

Asportare la guarnizione
Remove the gasket
Enlever le joint
Sacar la junta

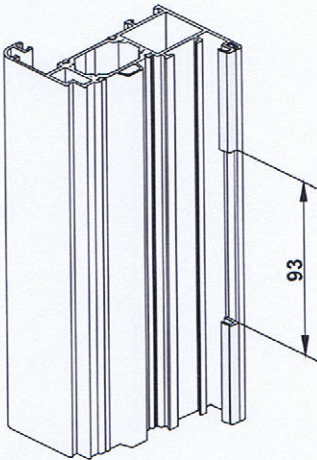

Sequenza di montaggio/Sequence assembly/Séquence de montage/Secuencia de montaje

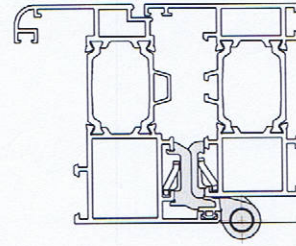
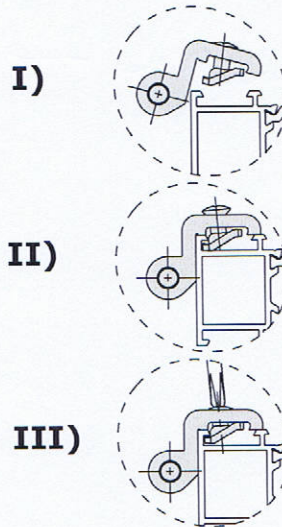

1121.20

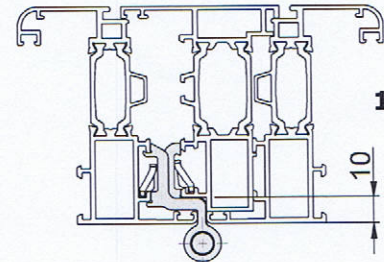

1123.20

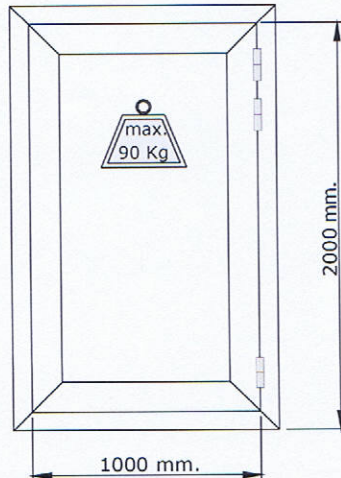
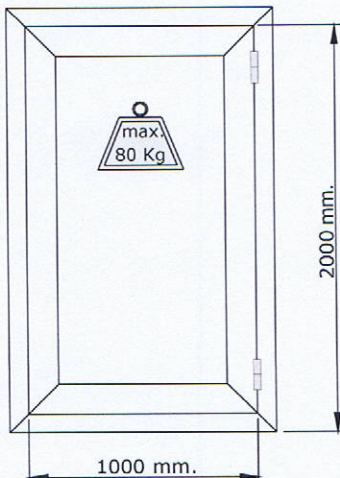

Tabella di adattabilità per profili italiani
Suitability table for italian profile

Estrusore	Profilo	1121.20	1123.20
PASSERINI	EKIP TH 83	•	•