

E' possibile ridurre la quota A tagliando il quadro da 8 mm
It's possible to reduce quote A cutting the 8 mm square pin

Lavorazioni

Machinings

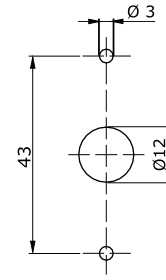

**** Art. 874.898**

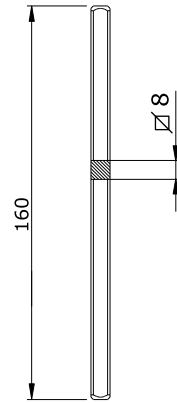

*** Art. 874.899**

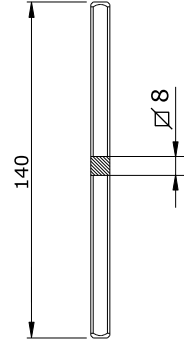
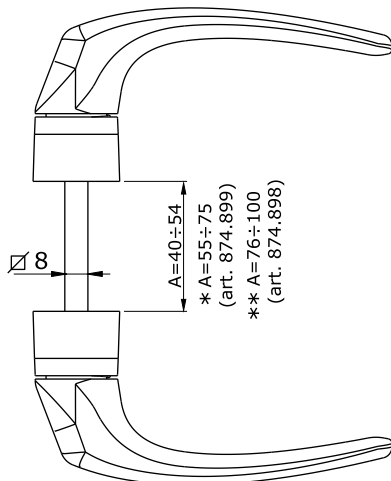
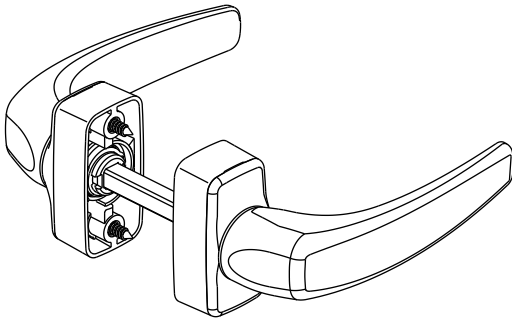
E' possibile ridurre la quota A tagliando il quadro da 8 mm
It's possible to reduce quote A cutting the 8 mm square pin

Lavorazioni

Machinings

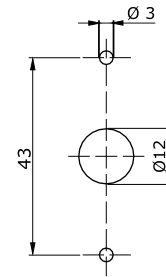

**** Art. 874.898**

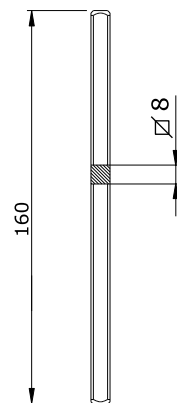

*** Art. 874.899**

